

AimShot[®]

BE READY *Est. 1998*



WIRELESS REMOTE LIGHTS AND LASERS
QUICK RELEASE M-LOK, KEYMOD, AND PICATINNY MOUNTS
BORE SIGHT KITS / REFLEX SIGHTS
GREEN, RED, AND IR LASERS
WHITE, GREEN, AND IR LIGHTS

WWW.AIMSHOT.COM



PROVIDING

- CIVILIAN
- LAW ENFORCEMENT
- MILITARY

- ORIGINAL PATENTED DESIGNS
- HIGH VALUE PRODUCTS
- REASONABLE PRICE
- PERFORMANCE

SINCE 1998

Contents

- 1. Wireless Revolution- Lasers & Flash Lights (2-9)**
TX890/TZ980 (4-7) KT8103 Gen II (8-9)
- 2. Quick Release Systems (10-15)**
KeyMod Q.R. (12) M-Lok Q.R. (13) Picatinny Q.R. (14)
- 3. Bore Sights, Arbors, and Kits (16-21)**
- 4. Reflex Sights (22-27)**
HG Elite (24-25) HG Pro (26) M3G/D3G Gen II (27)
- 5. Rechargeable Revolution (28-29)**
KT8106 (28) TXP (29)
- 6. Classic Rifle Light Kits (30-31)**
TX850/TX860 (30) TX870/TX950 (31)
- 7. Conceal Carry Pistol Lasers (32-33)**
KT6506 Slim Laser Series (32-33)
- 8. Classic Lasers (34-35)**
- 9. HeatSeeker (36)**
- 10. Mounting Systems (37)**
- 11. Light and Laser Accessories (38)**
- 12. AimShot Information (39)**
- 13. Bore Sight Arbor Fitment Guide (40)**

WIRELESS REVOLUTION

Don't be tied down by wired tape switches.



Go Wireless - evolve into the apex gunfighter with the KT8103 Gen II series of wireless lasers and the TX/TZ series of wireless remote pressure switch equipped flash lights.

Light and Laser Features

- All of the AimShot wireless lights and rifle lasers are waterproof and designed specifically for tactical/weapons mounting.
- Each light and laser comes with a full compliment of accessories- quick release mounts, wireless pressure switch, and batteries.
- The wireless remote provides additional redundancy compared to traditional pressure switches. In a traditional system if you break a cable or the pressure switch becomes inoperable, the device stops functioning. With the AimShot system, you have the wireless remote control as well as the primary on/off button on the back of the light/laser for extra security.
- The wireless remote will turn the light or laser on with the press of any of the buttons.

Wireless Remote Functions

- **Light wireless remote functions:** Press any button on the remote to turn the light on. Once the light is on, the first button turns the light off, while the other two allow the user to adjust the light output in stepless levels from 5% to 100% output. When turned off and back on, the previous output setting is remembered and utilized. Press button one to turn off the light, but pressing any button will activate the light again.
- **Laser wireless remote functions:** The wireless remote will turn the laser on with the press of any of the buttons. Button one turns the laser on and off, while the other two are designed for momentary activation- press the button to turn on the laser, and release to turn off. The first button leaves the unit on for hands free operation- press and release to turn on, and press again to turn it off.
- **Pairing a new remote:** quick and simple. Press and hold the master button on the unit and the remote at the same time and within seconds they are paired together.

When compromise free equipment is necessary.



All wireless lasers and tactical lights are waterproof, encased in black anodized 6061 T6 aluminum housings, and include quick release hardware.

WIRELESS REVOLUTION

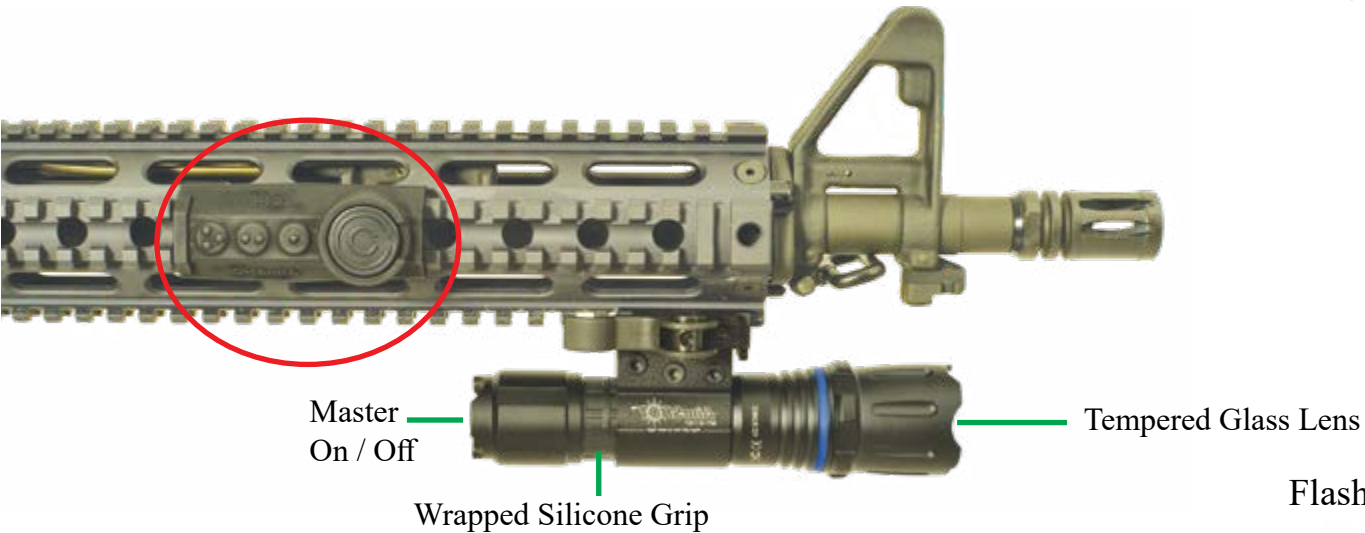

TX890 KIT

(Available in white or infrared LEDs)

- Evolved:** Remote capable of adjusting light output (5%-100%) and redundant switches for increased reliability
- Confident:** Silicon grip for sure handling
- Rugged:** Waterproof black anodized 6061 T6 aluminum housing
- Bright:** Cree LED delivering 550 lumens (FL1 testing standard)
- Compact:** Only 44mm x 39mm x 30mm
- Quick:** Quick-release from weapons to hand held in seconds without tools.
- Lightweight:** 5.5 oz.
- Tireless:** 1-6 hours continuous run time on 2 CR123A batteries (included)

Flash Light Mount



Picatinny Quick Release



Wireless Remote



WIRELESS REVOLUTION

TX890 Lights

Modeled after the AimShot TX860 light but with additional functionality, we have paired the lights with our new wireless rail mounted pressure switch. As with all AimShot tactical lights, the TX890 comes as a complete kit with everything needed to be fully functional out of the box. Tactical light, quick release and hard mount for picatinny rails, batteries and of course the revolutionary wireless rail mounted pressure switch.

Two versions are available

- 550 lumen CREE bright white LED for traditional lighting needs.
- **Infrared (IR) LED (850nm)** version for use with Night Vision gear. Invisible to the naked eye, it works with all the latest NVG.

Both models have fully adjustable power output. Instead of only having low/medium/high you now have the capability of infinite adjustment levels on the fly to custom tailor your output to your needs. Running NVG inside a house and don't want to wash out all the details, now it's easy to adjust the output.

Many innovations were developed to provide the best heat dissipation as well as maintaining waterproofness.

Features that no other tactical light can offer at a price that can't be beat!

- HEAT DISSIPATION
- HEAT TRANSFER MEDIA
- O-RINGS FOR WATERPROOFING

THE FIRST WIRELESS WEAPON LIGHT

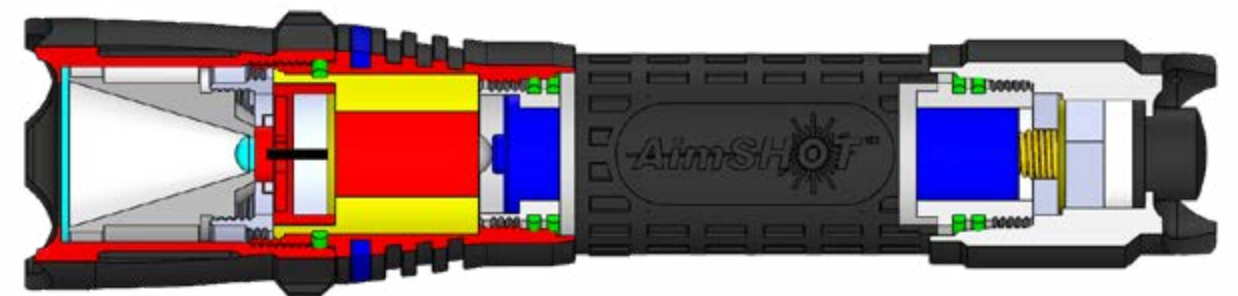

ALL AIMSHOT FLASHLIGHTS ARE DESIGNED FOR USE ON A WEAPON. THEY ALL ARE BUILT TO THE HIGHEST STANDARDS WITH: MACHINED ALUMINUM REFLECTORS, PROTECTED TAIL CAPS AND HIGH GRADE ALUMINUM ALLOY BODIES FOR MAXIMUM PROTECTION.

TZ980 Variable Focus Flashlight

(Available in white and infrared)

- Evolved:** Remote capable of adjusting light output (5%-100%) and redundant switches for increased reliability
- Confident:** Silicon grip for easy handling
- Versatile:** Adjustable focusing bezel ring (10-40 ft. pattern at 100 ft.)
- Quick:** Quick-release from weapons to hand held in seconds without tools.
- Bright:** Cree LED delivering 450 lumens
- Lightweight:** 10.3 oz.
- Tireless:** 1-6 hours continuous run time with 2 CR123A batteries (included)
- Rugged:** Constructed from black anodized 6061 T6 aluminum, waterproof
- Rechargeable:** works with rechargeable 18650 batteries (not included)
- Portable:** Belt-mounted carry pouch included

**PATENT
PENDING**

Included Accessories

Wireless Remote

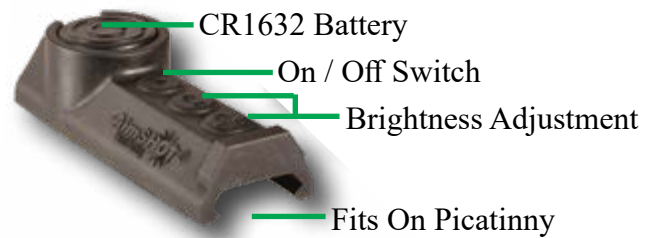

Carry Pouch



Flash Light Mount



TZ980 Adjustable Beam Lights

Designed specifically for hunters, the new Adjustable Beam TZ980 flashlight is combined with our new wireless rail mounted pressure switch. As with all AimShot lights, the TZ980 comes as a complete kit with everything needed to be fully functional out of the box. Variable focus light, quick release and hard mount for picatinny rails, batteries and of course the revolutionary wireless rail mounted pressure switch.

Two versions are available

- 550 lumen CREE bright white LED for traditional lighting needs
- Infrared (IR) LED (850nm) version for use with Night Vision gear. Invisible to the naked eye, it works with all the latest NVG.

Both models have fully adjustable power output. Instead of only having low/medium/high you now have the capability of infinite adjustment levels on the fly to custom tailor your output to your needs. The IR version works great with Night Vision gear, allowing you to search for your prey, then zoom in for precise targeting and identification.

Many innovations were developed to provide the best heat dissipation as well as maintaining waterproofness. In the past you could not have an adjustable beam light that was waterproof. With the patented design from AimShot you can have adjustable beam pattern AND a waterproof design. The TZ980 lights are compatible with rechargeable 18650 batteries as well as the CR123A batteries. Fully adjustable beam pattern, adjustable light output, waterproof, and wireless remote.

It's every hunters deam and every varmint's nightmare!



ALL AIMSHOT FLASHLIGHTS ARE DESIGNED FOR USE ON A WEAPON. THEY ALL ARE BUILT TO THE HIGHEST STANDARDS WITH: MACHINED ALUMINUM REFLECTORS, PROTECTED TAIL CAPS AND HIGH GRADE ALUMINUM ALLOY BODIES FOR MAXIMUM PROTECTION.

WIRELESS REVOLUTION

KT8103 GEN II

- Evolved:** Redundant switches for increased reliability
- Precise:** 1 MOA adjustments for windage/elevation with tactile feedback
- Rugged:** Constructed from black anodized 6061T6 Aluminum, waterproof
- Compact:** 40mm x 44mm x 30mm
- Lightweight:** 2.5 oz.
- Quick:** Quick-release for adding or removing from weapons systems without tools.
- Tireless:** 6 hours continuous run time with CR2 battery (remote uses CR1632 battery) included

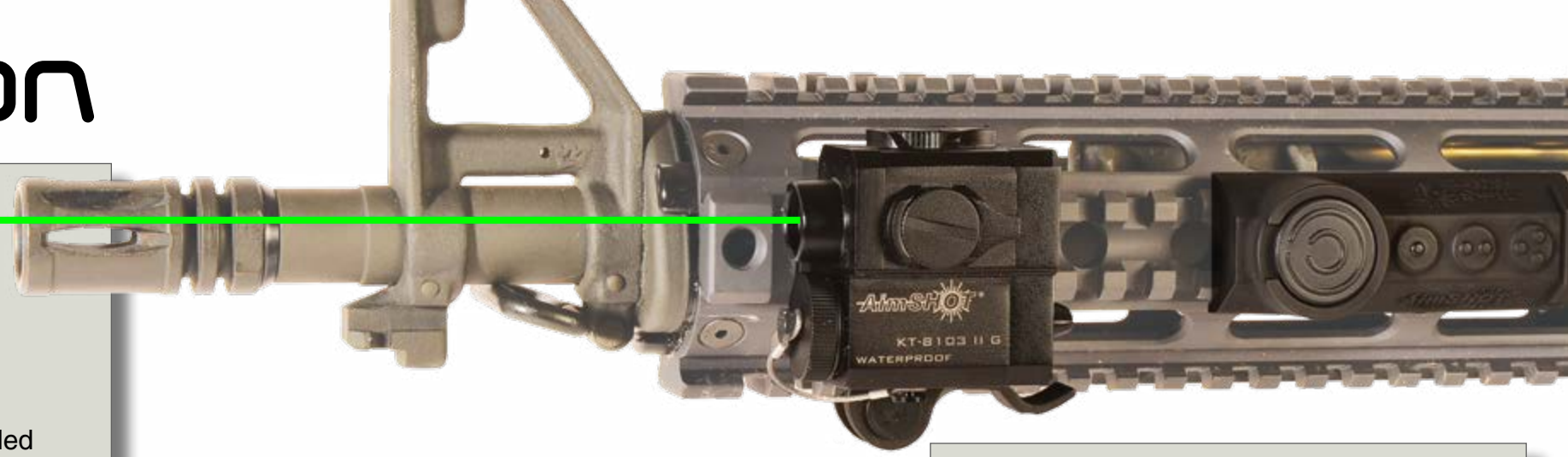

GR KT8103 Gen II Green

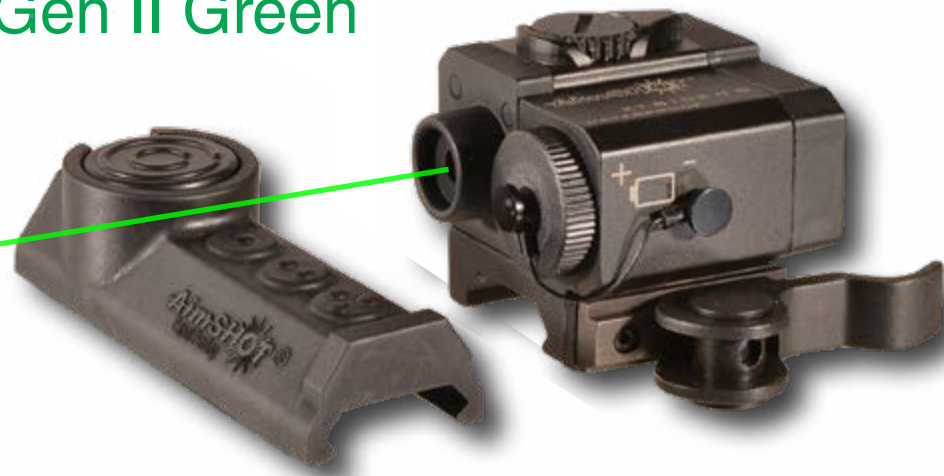

IR KT8103 Gen II IR

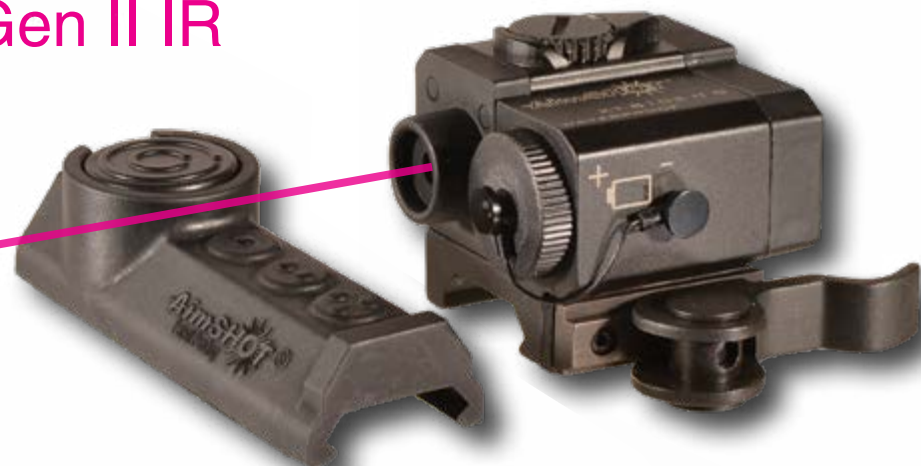

Rear View

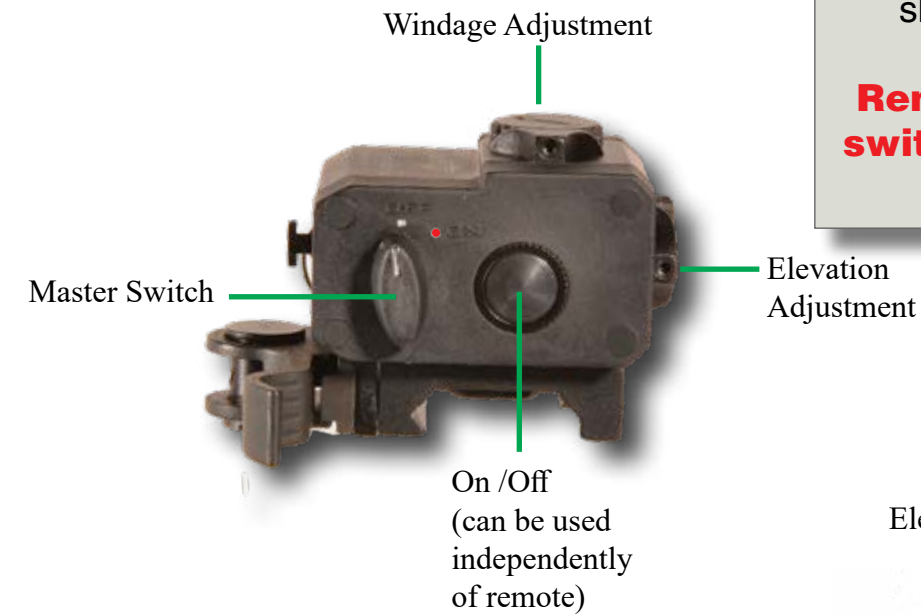

Windage and elevation changes are tool free and the adjusters are partially shrouded to prevent accidental movement.
Remember to turn off master switch to preserve battery life when not in use!

Side View

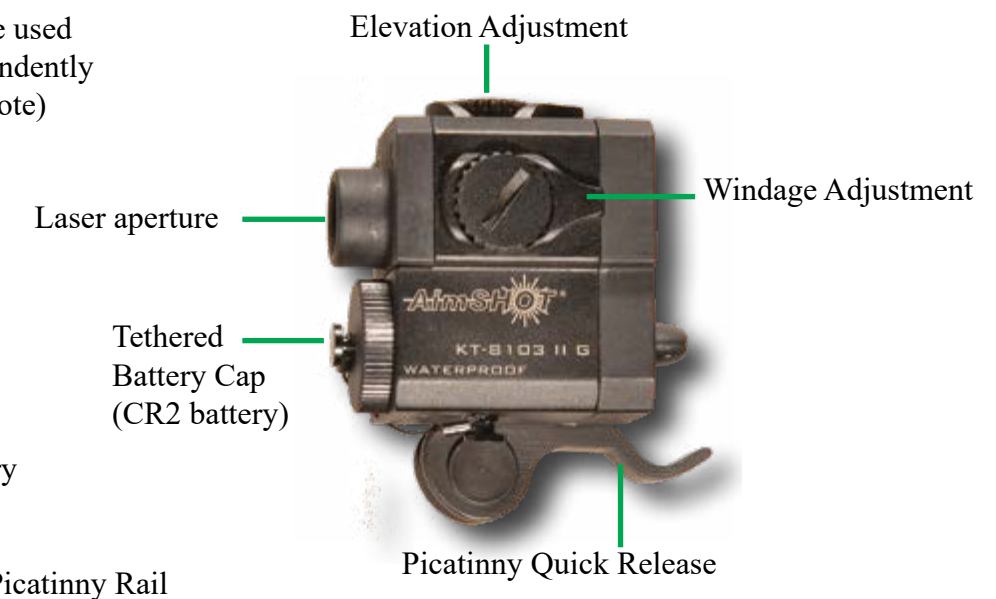

Wireless Remote

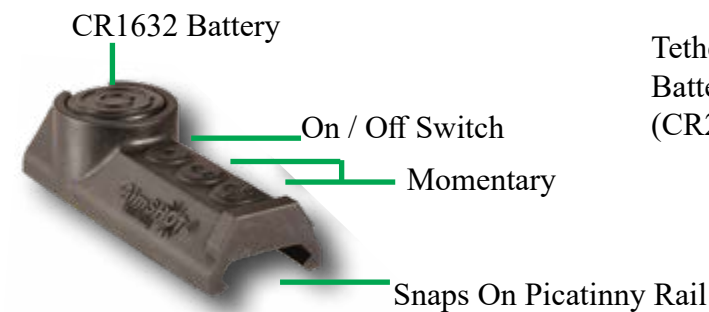

Built in redundancy- unlike traditional pressure switches where a pressure switch failure leaves you with no laser, on the KT8103 system you have the option to control the laser from the main body of the laser, as well as from the wireless remote. You are always in control!

QUICK RELEASE

M-LOK VS KEYMOD

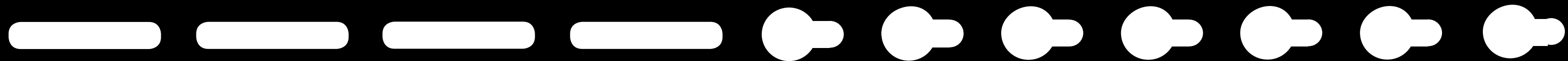

ATTENTION!

M-Lok rail users- want to change accessories without ANY tools? AimShot has tool free M-Lok Quick Release mounts. Turn your rifle into a modular speed demon and change out accessories in seconds!

ATTENTION!

If you prefer KeyMod- here is the system you have been waiting for! AimShot has tool free adjustable KeyMod Quick Release mounts. Turn your rifle into a modular speed demon and change out accessories in seconds!

NEW LOCKING M-LOK QR MOUNTS

PATENTED

LOCKING M-LOK QUICK RELEASE

- Quick:** Two-button press to securely connect and remove with no tools
- Sturdy:** **New and Improved** Integrated locking mechanism holds fast and strong
- Tough:** black anodized 6061 T6 aluminum housing
- Versatile:** Connect almost any accessory in seconds

**Must use with metal M-Lok rails between 2-3mm thick
Will not work on MOE/Plastic Rail systems!!**

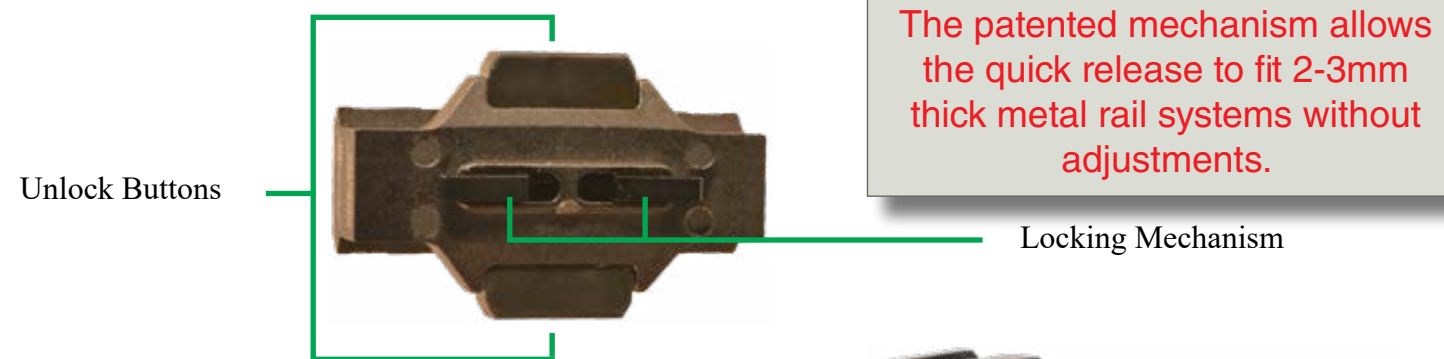

KEYMOD Q.R. MOUNTS

PATENTED

IMPROVED

KEYMOD QUICK RELEASE

- Quick:** Press down and slide forward to securely lock in place
Unlock with two-button press and slide towards receiver to remove with no tools
- Sturdy:** Integrated locking mechanism holds fast and strong
- Tough:** black anodized 6061 T6 aluminum housing coupled with steel fasteners
- Versatile:** Connect almost any accessory in seconds
- Adjustable:** Adjustment screws allow you to fit QR to KeyMod rails that are out of spec

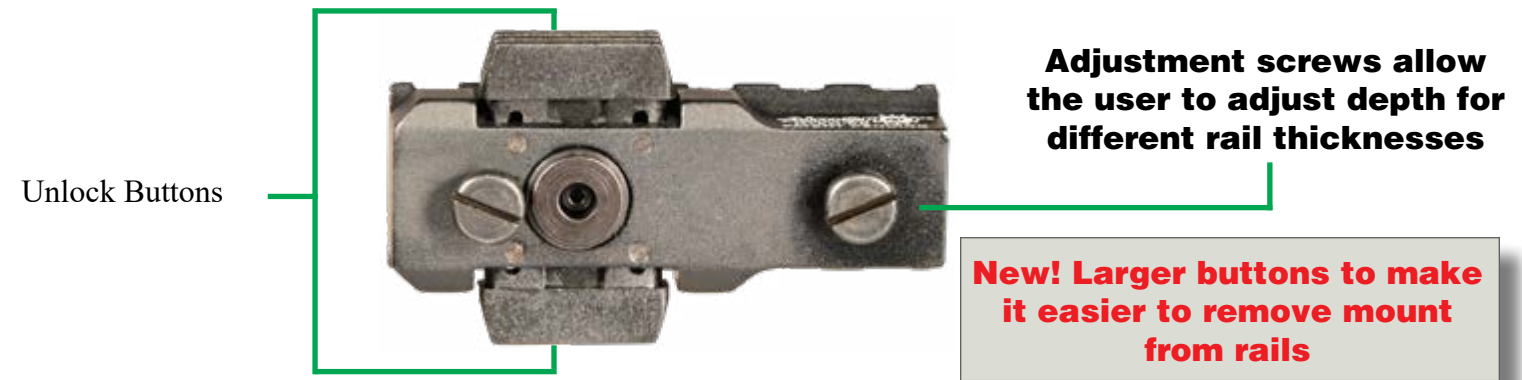

MTML-BA: Quick release Harris-style bipod adapter



MTML-QD: Hybrid Picatinny & Q.D. attachment point (Q.D. sling not included)



MTML-40PR: Quick release 40mm Picatinny rail

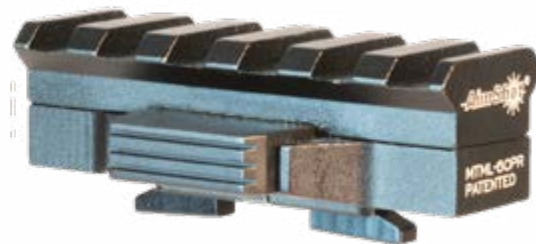

MTML-60PR: Quick release 60mm Picatinny rail



MTML-140PR: Quick release 140mm Picatinny Rail

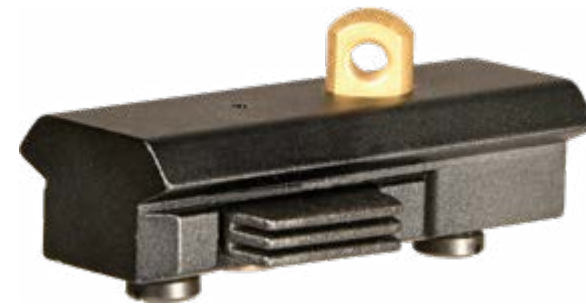

MTKMQR-BA: Bipod Mount - Quick release Harris-style bipod adapter/Sling mount



MTKMQR-PR: Picatinny Rail Quick release locking 60mm Picatinny Rail

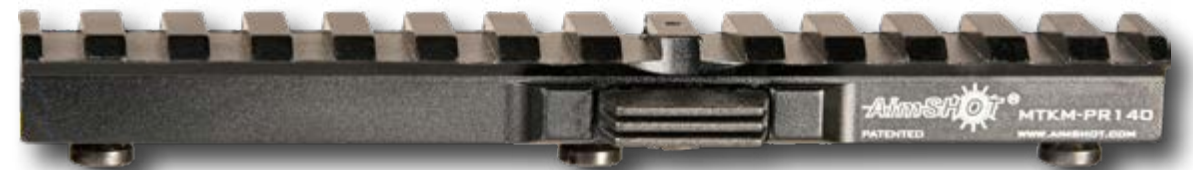

MTKMQR-140PR: Quick release locking 140mm Picatinny Rail



MTKMQR-LM: Light/Laser Mount- Quick release 1" laser/flashlight mount with 7/8" bushing

PICATINNY Q.R. MOUNTS

PICATINNY QUICK RELEASE

- Quick:** Locks into place by closing the lever- no tools needed!
- Versatile:** Turn any standard accessory into a quick-release accessory
- Sturdy:** Made from black anodized 6061 T6 machined aluminum
- Adjustable:** Easy tension adjustment to fit any out of spec picatinny rail

Video Mount: Quick release base for any adhesive mounted action camera such as GoPro.

Bipod Mount: Quick release for Harris-style bipod or traditional sling mount

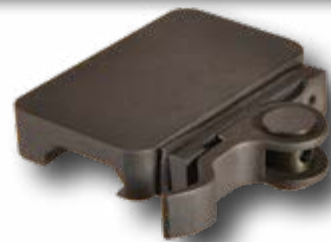

MT61173



MT61174



MT61172-40SP

Standard Profile
for metal and plastic accessories that need full depth for mounting. 40mm and 60mm lengths available



MT61172



MT61172-40LP

Low Profile
for metal accessories that prefer low profile mounting closer to centerline of the bore



MT61172-60LP



MT61172-140LP

QUICK RELEASE MOUNT DETAILS

KEYMOD AND M-LOK QUICK RELEASE

KeyMod and M-Lok quick release mounts are a new patented design that is constantly being refined. They allow you to remove and attach accessories quickly and tool free. No longer do you need to keep on hand tools or use different hardware to mount your accessories. Once your accessory is attached to the appropriate AimShot mount, squeeze to attach, squeeze to detach. Your accessory is firmly and solidly mounted to your rail system. Lightweight aluminum housing coupled with steel hardware for long life and light weight. Different designs allow you to couple your bipod, lights, lasers, or any other rail accessory to your KeyMod or M-Lok rails.

KeyMod QR system- New Improved mounts utilize larger buttons to make it even easier to attach and detach the mount from the rails. The base allows you to adjust the height of the retaining screws to accommodate any thickness rail, even if cerakoted or painted.

M-Lok QR system- New Improved locking system automatically adjusts for fit all metal M-Lok rails (not currently compatible with MOE rails) and locks in place for positive attachment and ability to withstand the abuse of full auto rates of fire.

MUST BE USED ON METAL RAILS BETWEEN 2-3MM THICK!!!

M-Lok



KeyMod

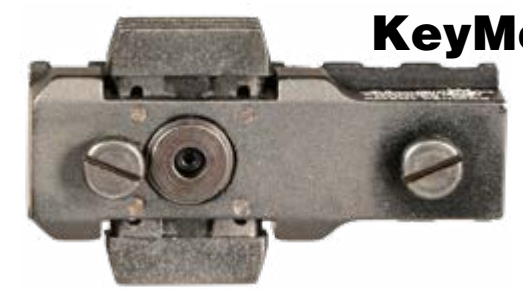

PICATINNY QUICK RELEASE

All of our picatinny rail quick release mounts are made from 6061-T6 alloy giving them solid and durable construction. They offer quick turn screw adjustment to fit most picatinny rails even if they are bit out of specification. Adjusts quickly and easily utilizing a simple and effective system to properly fit any rail.



BORE SIGHTS, ARBORS & KITS



AimShot Bore Sight System and Kits

The AimShot laser bore sight system is the **most advanced, best value, complete, and accurate system on the market**. Our complete bore sight kits offer the capability to bore sight the 17HMR to 50BMG and most everything in between.

As the original patent holder for the chamber based bore sights, AimShot has been producing and refining our bore sight system since 1998. While there are many cheap copies on the market, **there are NONE that use the same quality materials and system approach** that are what set AimShot apart from every other system. Do not judge AimShot quality and bore sight function by lesser products.

To further show **continuing innovation, only AimShot has developed a full line of power solutions for the laser bore sight**. The original bore sights with the internal watch batteries (*BS part numbers*), the next generation with a wired external battery pack (*BSB part numbers*) and the latest generation- a Modular Battery System that gives you the option of internal or external battery packs (*MBS part numbers*).

We always recommend the external or modular battery pack for most users except in cases where you *have* to close the chamber to bore sight the weapon (many semi auto pistols).



BORE SIGHTS & ARBORS

PATENTED



For Every Enthusiast, Marksman, Sharpshooter and Expert. Our one of a kind bore sight system uses one laser for most rifle calibers and one laser for most pistol calibers. In addition there is no contact to the rifling.



The heart of the AimShot bore sight systems is our laser. Since **the laser is the most crucial part of the system that defines the accuracy**, we pour our heart and soul into the base laser. For rifles, this is the 223 laser, and for pistols, the 30 carbine laser. Once you have the base 223 laser for rifles, you purchase additional arbors to fit the 223 laser into any other caliber/chamber. **All of our kits include the 223 laser as well as a group of arbors to fit your needs.**

AimShot offers **21 different rifle caliber arbors** to help you bore sight most common (and some not to common!) calibers on the market- with new calibers being offered all the time.

For pistols, we offer 5 different arbors that utilize the 30 carbine laser bore sight to cover most calibers. Our pistol kits also includes a 9mm laser bore sight as well.

There are 4 calibers that need specific laser bore sights that are not part of the arbor fitments- **17 HMR, 22LR, 204 Ruger and 9mm.**

Our arbors are meticulously machined of solid brass to precise tolerances to fit your chamber correctly with no movement.

The **AimShot arbor system allows you to bore sight multiple calibers at a greatly reduced cost.** Once you have the base laser, you just add additional arbors for additional calibers.

Arbor Fitment Guide on Page 22

PATENTED

Dual Power Sources

Internal- Uses button type batteries for closed chamber applications. **BS part numbers**

External- Uses permanently wired battery box that houses 2 x AAA for 20+ hour run time for open chamber applications. **BSB part numbers**

Modular- Includes *both* a removable wired battery box and button type batteries for use with open or closed chamber applications. **MBS part numbers. This is what we always recommend.**

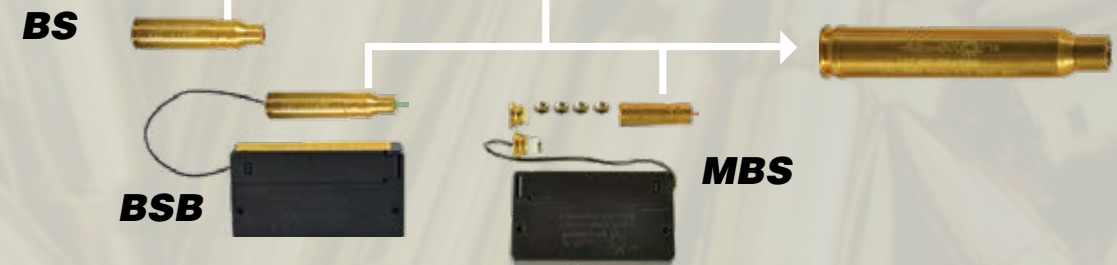

Calibers Offered as Individual Laser Diodes

(These are stand alone bore sights and do not use any arbors)

.17 HMR



22LR



204
Ruger



9mm



Laser Variation Part Number Available by Caliber

Laser Diode	Internal batteries	External battery box	Modular dual power
.223 Green	N/A	BSB223G	N/A
.223 20x Red (brighter)	BS223 20x	N/A	MBS22320x
.223 Red	BS223	BSB223	MBS223
30 Carbine	BS30	BSB30	MBS30
9mm	BS9	BSB9	MBS9
.17 HMR	N/A	BSB17	N/A
.22LR	N/A	BSB22	N/A
.204	BS204	N/A	MBS204

BORE SIGHTS KITS

Save big when bore sighting multiple calibers with these pre-built kits for popular calibers

PATENTED



MBS Kit 1

MBS223 .223 bore sight modular battery pack
243 arbor
30-06 arbor



Military Kit

MBS223 .223 bore sight modular battery pack
243/308 arbor
7.62x39 arbor



MBS Kit 2

MBS223 .223 bore sight modular battery pack
243 arbor
30-06 arbor
264 Win arbor



Hunting Kit

MBS223 .223 bore sight modular battery pack
243/308 arbor
Creedmoor arbor
PRC arbor



MBS Kit 3

MBS223 .223 bore sight modular battery pack
243 arbor
30-06 arbor
264 Win arbor
7.62x39 arbor



Big Hunting Kit

MBS223 .223 bore sight modular battery pack
243/308 arbor
30-06 arbor
264 Win arbor
Creedmoor Arbor
6.5 Grendel/6ARC
PRC arbor



KT Pistol

BS30 30 carbine bore sight
BS9 9mm bore sight
500S&W arbor
38 Special arbor
40 S&W arbor
44 Rem arbor
45 ACP arbor
45 Colt arbor

KT-MBS Pistol

MBS30 30 carbine modular bore sight
MBS9 9mm modular bore sight
500 S&W arbor
38 Special arbor
40 S&W arbor
44 Rem arbor
45 ACP arbor
45 Colt arbor



KT Rifle Red

.223 Red Bore sight
Modular battery
243 win arbor
264 win arbor
30-06 arbor
30 30 arbor
7.62 arbor
12 gauge arbor

KT Rifle Green

BSB223-Green
External battery
243 win arbor
264 win arbor
30-06 arbor
30 30 arbor
7.62 arbor
12 gauge arbor



KT Master Red or Green - All 21 Arbors!

223 Bore sight (Red or Green options)	8mm Rem Arbor	12 Gauge Arbor
243 win Arbor	30-06 Arbor	RSUM Arbor
264 win Arbor	30/30 Arbor	375 H&H Arbor
WSM Arbor	7.62x39 Arbor	450BM Arbor
6.5 Creed Arbor	Weatherby Arbor	PRC Arbor
224V/6.8SPC Arbor	6.5Grendel/6ARC	50 BMG Arbor
		Norma Mag Arbor
		338 Lapua Arbor
		22-250 Arbor

Arbor Fitment Guide

Arbors for 223 bore sight laser

AR12GA	12 Gauge
AR20GA	20 Gauge
AR243	243 Win / 308 Win / 7mm-08 / 260 Rem / 338 Fed 7.62x54r / 7.62x51 / 444 Marlin / 8mm Mauser
AR264	264 Win / 300 Win Mag / 300 Wea / 7mm Rem Mag 340 Wea / 257 Wea / 358 Norma Mag / 338 Win Mag
AR30-30	30-30 Win / 32 Win / 375 Win / 225 Win
AR30-06	30-06 / 25-06 / 270 Win / 35 Whelen 338-06 / 280 Rem / 300 Savage
AR6.5CREED	6mm Creedmoor / 6.5 Creedmoor / 6.5x47L
AR762x39	7.62x39 / 220 Swift / 303 British / 35 Rem
ARWEA	270, 300 Weatherby / 7mm Wea Mag / 340 Wea Mag
ARWSM	270, 300 WSM / all WSSM
ARRSUM	300 RSAUM / 7mm RSAUM / 7mm RUM / 300 RUM
AR375	375 H&H
AR22-250	22-250 / 250 Sav / 7mm WSM / 7mm RSM
AR8MMREM	8mm Rem / 416 Rem Mag
AR50BMG	50 BMG
ARPRC	6.5 PRC / 7mm PRC / 300 PRC
ARNORMA	300 Norma Mag / 338 Norma Mag
AR65G/6ARC	6.5 Grendel / 6mm ARC
AR338LM	338 Lapua Mag
AR450BM	450 Bushmaster
AR224V/6.8SPC	224 Valkyrie / 6.8 SPC

**New! Available
now and
included with
the Master 2
Bore Sight Kit**

Arbors for 30 Carbine bore sight laser

AR38SPEC	38 Spec / 357 Mag
AR40SW	40 S&W / 10mm / 357 Sig
AR44SW	44 S&W Spec / 44 Mag
AR45ACP	45 ACP / 45 GAP / 400 Cor-Bon
AR45COLT	45 Colt / 45-70 / 460 S&W Mag / 454 Casull
AR500SW	500 S&W Mag / Special / JRH

No arbors required for the 17HMR, 22LR, 9mm, 204 Ruger

BE PROFICIENT
BE RESPONSIBLE
BE INFORMED
BE VIGILANT
BE ACCURATE
BE TACTICAL
BE EDUCATED
BE EFFECTIVE
BE READY

AimShot[®]
BE READY Est. 1998

REFLEX SIGHTS



HG ELITE



HG PRO



M3G/D3G

REFLEX SIGHTS

Three versions to fit your needs and price point

HG Elite

Years of experience manufacturing reflex sights culminate in a top level sight. True 2 MOA crystal clear green reticle with 9 levels of brightness for daylight visible aiming, or IR illumination for use with NVG. Solid one piece construction for light weight and durability. Three different reticle options from the factory to match the users needs. 8000 hours of use from a single CR2 battery with auto shutoff.

HG Pro

Our heavy duty workhorse reflex sight. Built like a tank, extremely visible green reticle with a classic crosshair reticle design. Large viewing window for great field of view and parallax free. 6000 hours of illumination from a single CR123A battery. Waterproof and built to last!

M3G/D3G Gen II

Budget price with top level features. 4 user selectable reticle choices on each unit, with adjustable brightness. Latest generation now with smaller 2 MOA dot.

REFLEX SIGHTS

HG ELITE

(Available In 3 Single Reticle Options)

- Evolved:** Built in inertia switch activates power and after 5-10 min. of inactivity deactivates power for superior battery life and rapid response capability, over 8000 hours on a single CR2 battery
- Precise:** 1 MOA adjustments for elevation/ windage with tactile feedback
- Confident:** Nitrogen filled housing for flawless operation in adverse weather conditions
- Adaptable:** 9 step brightness for green reticle and true IR reticle (IR for use with night vision systems- 850nm)
- Durable:** Exterior machined from black anodized 6061 T6 aluminum and carbon fiber nylon composite interior with multi-coated tempered lens
- Lightweight:** 8 oz.
- Customizable:** 3 green reticle available from the factory, all with true 2 MOA center dot
- Quick Release:** Built in adjustable picatinny rail quick release

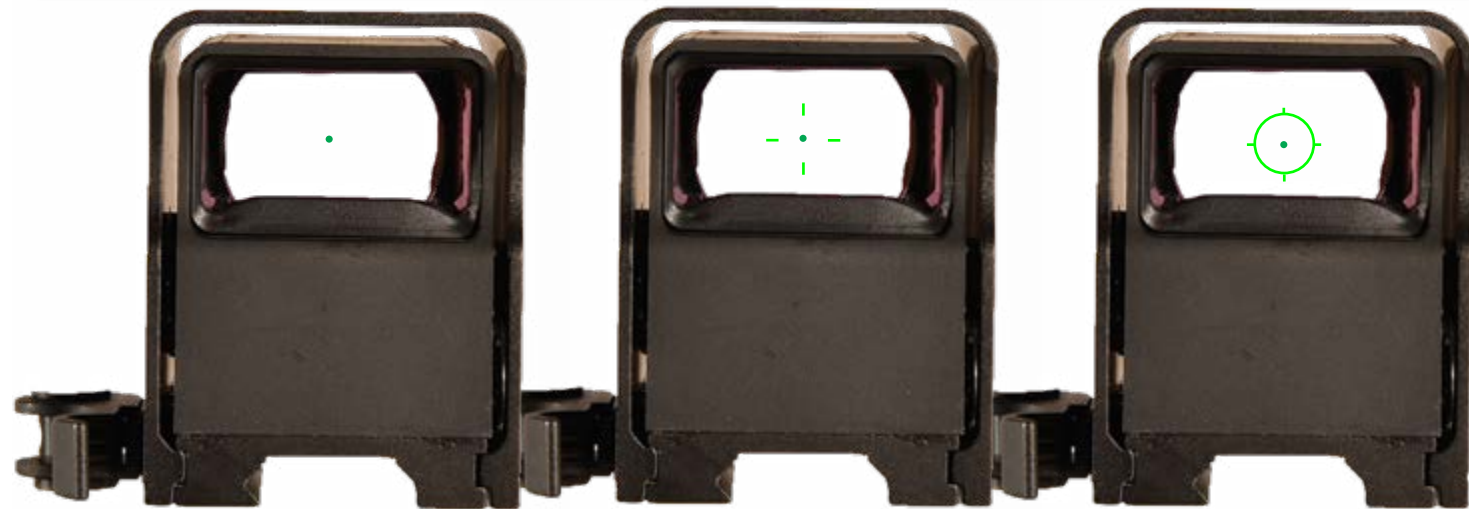

Reticle A - 2 MOA Dot

Reticle B - 2 MOA Dot w/ crosshairs

Reticle C - 2 MOA Dot w/ 65 MOA circle



REFLEX SIGHTS

HG PRO

- Evolved:** Auto shut off after 4 hours
- Confident:** 34mm wide view parallax-free lens
- Precise:** Adjustments for windage/elevation with tactile feedback
- Adaptable:** 9 step adjustable reticle brightness, with 2 night vision levels
- Rugged:** Waterproof Aluminum alloy construction with 3mm thick multi coated lens
- Adaptable:** CR123 battery for long life, over 6,000 hours!!
- Transportable:** Includes neoprene dust cover and contoured storage case

Green Crosshair
Reticle

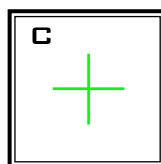

Red Reticle Selection

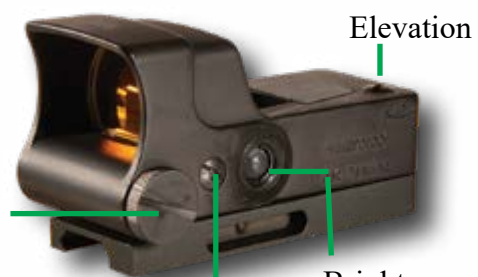

CR123
Battery
Cap

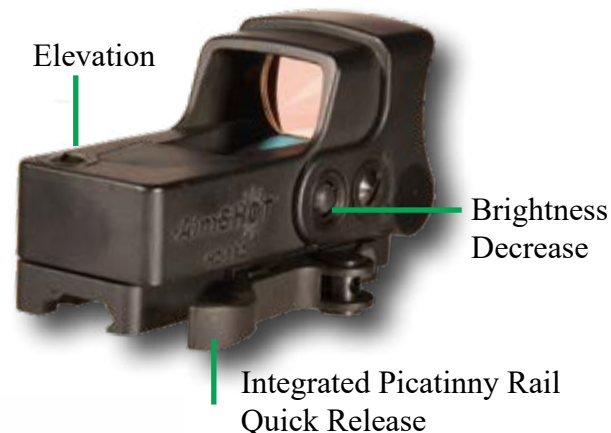
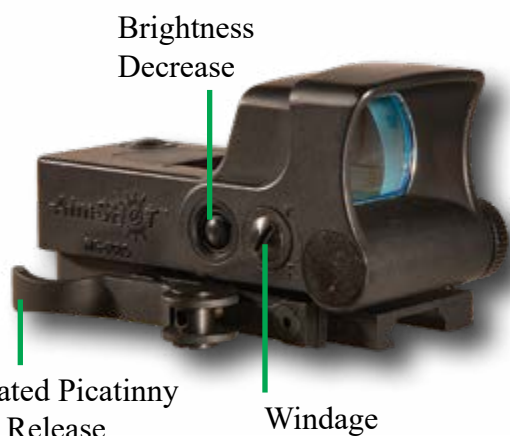

Integrated Picatinny
Quick Release

Windage

Included Accessories

Dust Cover

Storage Case



M3GII / O3GII

(Available in 2 Multi-reticle Options)

- Evolved:** Auto shut off after 4 hours, over 4000 hours off a single CR2 battery (included)
- Customizable:** 2 green reticle versions available- each with 4 built in selectable reticles
- Rugged:** Aluminum alloy construction with 3mm thick tempered parallax free lens
- Adaptable:** 9 step adjustable reticle brightness
- Compact & Light weight:** 83mm x 43mm x 52mm, 6.2 oz.
- Quick Mounting:** tool free mounting on picatinny and weaver rails

M3GII

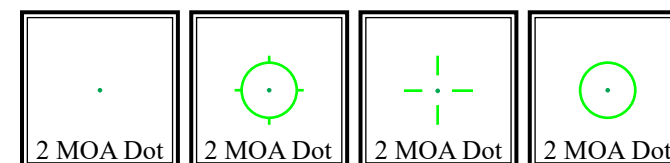

4 Reticles In One Device

O3GII

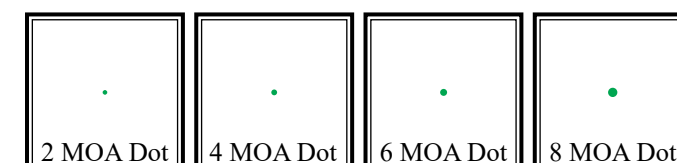

4 Reticles In One Device



Mount
Release

Reticle
Selector



Mount
Release

Reticle
Selector

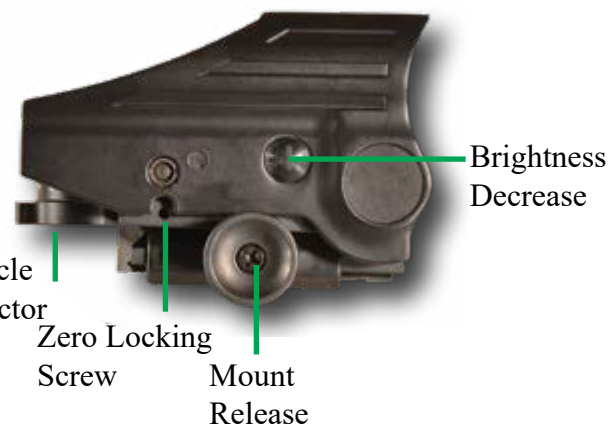

Reticle
Selector

Zero Locking
Screw

Mount
Release

Brightness
Decrease

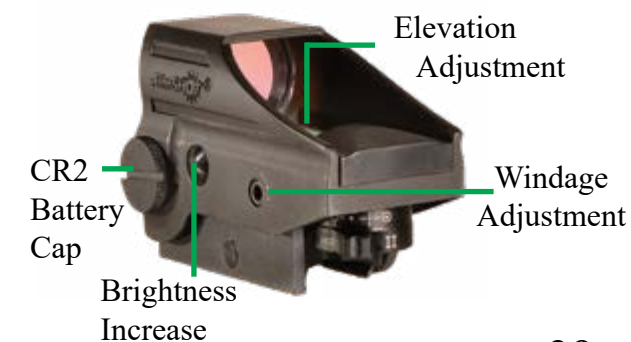

Elevation
Adjustment

CR2
Battery
Cap

Brightness
Increase

Windage
Adjustment

RECHARGEABLE

Don't try to replace batteries during an emergency.

REVOLUTION

Our Micro-USB chargeable systems are the easiest to maintain.

KT8106 RECHARGEABLE GREEN LASER/ LIGHT COMBO

- Efficient:** Micro-USB charging port with included cord and USB wall Plug, charge anywhere!
- Adaptable:** Mounts to any length Picatinny or weaver rail with included hardware
- Customizable:** Toggle through 5 modes (Light, Strobe, Laser, Light+Laser, Strobe+Laser)
- Powerful:** <5 MW, 532 NM green laser and 100 lumen light with up to 4 hr. continuous operation
- Precise:** Windage and elevation controls with ambidextrous on/off
- Functional:** User replaceable Lithium Ion battery pack. Inexpensive to have spares or replace
- Tough:** Carbon fiber reinforced nylon polymer with black anodized 6061 T6 aluminum alloy- water resistant
- Light weight:** 1.8 oz.
- Compact:** 45mm x 29mm x 30mm

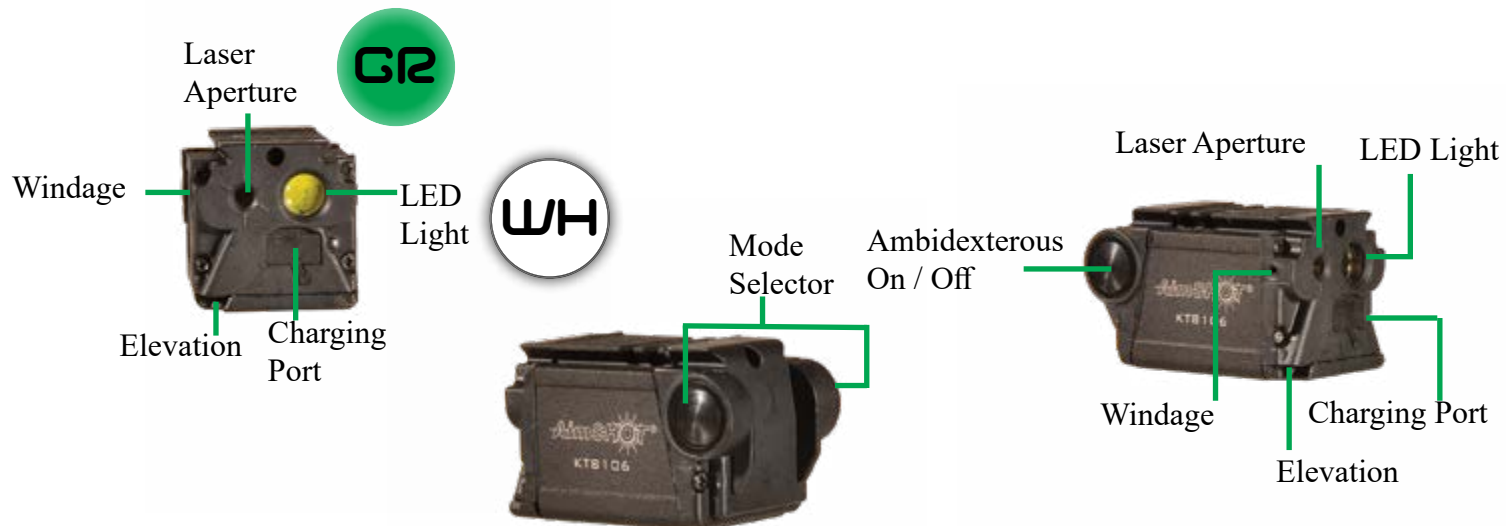

Included micro USB retractable charging cord and wall outlet



Included Mounting Hardware

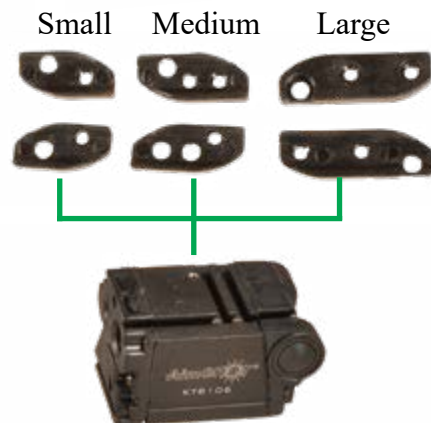

TXP RECHARGEABLE FLASH LIGHT

- Efficient:** Micro-USB charging port with included cord and USB wall plug, charge anywhere!
- Quick:** Mounts directly to most rail systems without bolts or tools
- Powerful:** 130 lumens with 1-4 hour of continuous run time (dependent on output settings)
- Light weight:** Nylon carbon fiber composite housing weighs less than 2 oz.
- Adaptable:** The light is adjustable front to rear on the mount to fit short or long rail systems.
- Options:** 3 modes (High, Strobe, Low), ambidextrous buttons
- Light weight:** 1.8 oz.
- Compact:** 63mm x 25mm x 36mm

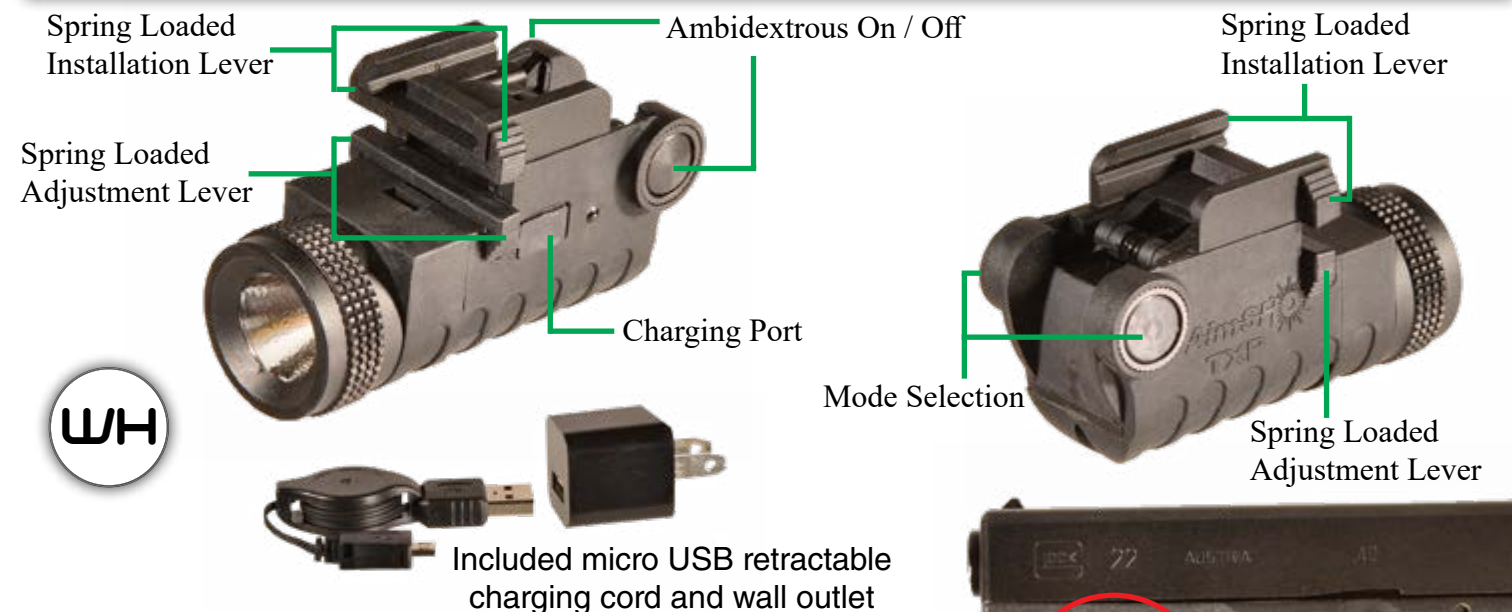

Included micro USB retractable charging cord and wall outlet



Adjusted to fit closest to trigger housing on full size pistol



Adjust light front to rear on the mount to fit compact pistols that have very short picatinny rails



CLASSIC RIFLE LIGHT KITS



WH

TX850 KIT

- Powerful:** 400 lumens
- Smart:** Comes with both standard on/off tail cap and rail mounted pressure switch as well as a picatinny rail light mount
- Sturdy:** Comes with hard mount Picatinny hardware
- Portable:** 37mm x 141mm and 5.3 oz..
- Endurance:** 2.5-6 hour run time on two included CR123A batteries
- Durable:** Waterproof black anodized 6061 T6 aluminum alloy
- Adaptable:** High, strobe and low settings



WH

TX860 550 LUMEN KIT

- Powerful:** 550 lumens
- Endurance:** 1-10+ hrs. run time on two included CR123 batteries
- Portable:** 35mm x 143mm and 5.35 oz..
- Sturdy:** Comes with quick-release and hard mount Picatinny mounts
- Smart:** Comes with standard on/off tail cap and rail mounted pressure switch
- Durable:** Waterproof black anodized 6061 T6 aluminum alloy
- Adaptable:** High, medium and low settings



GR

TX 870G GREEN KIT

- Powerful:** 350 lumens
- Endurance:** 2+ hrs. run time on two CR123 batteries
- Portable:** 8mm x 155mm and 7.4 oz..
- Hunting focused:** Green light is less alarming to wildlife
- Night Sight:** Green light disturbs low light vision less than white light
- Smart:** Comes with standard on/off tail cap and rail mounted pressure switch
- Sturdy:** Comes with hard mount Picatinny hardware and batteries
- Durable:** Waterproof black anodized 6061 T6 aluminum alloy
- Adaptable:** High, strobe and low settings

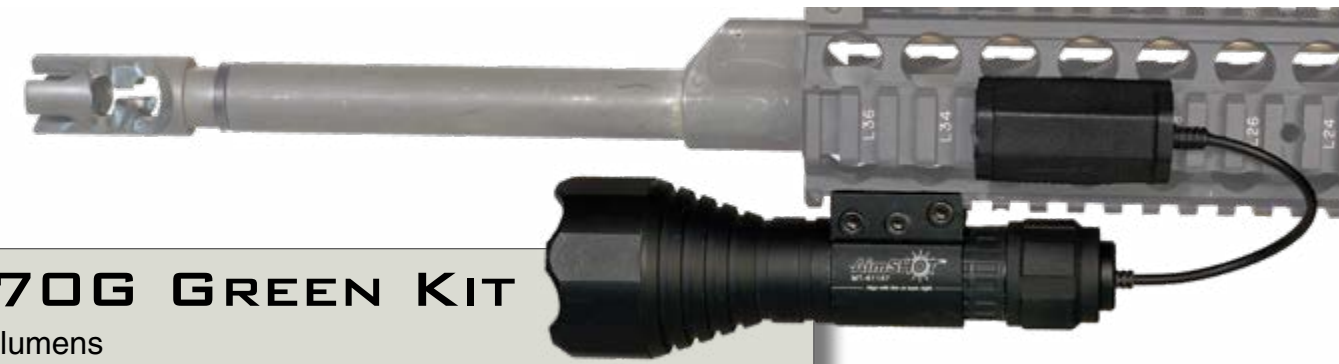

WH

TX 950 KIT

- Powerful:** 450 lumens with a large reflector for better focus at distance
- Endurance:** 2.5-6 hours run time on three CR123 lithium batteries
- Smart:** Comes with both standard on/off tail cap and rail mounted pressure switch
- Sturdy:** Comes with hard mount Picatinny hardware
- Portable:** 5mm x 180mm and 11.5 oz..
- Durable:** Waterproof black anodized 6061 T6 aluminum alloy
- Adaptable:** High, strobe and low settings

CONCEAL CARRY

PISTOL LASERS

The KT6506 laser series offers a slim fit, ambidextrous use, and snag free carry solution



KT6506 LASER SERIES

- Adaptable:** Comes in 8 models for custom fit
- Powerful:** : 650 nM red laser <5mw
- Enduring:** 3 hr. life on 1/3N battery
- Light:** Nylon and Carbon Fiber construction 1/2 to 3/4 oz.
- Smart:** Ambidextrous operation
- Accessible:** Easy access battery compartment

CLASSIC LASERS

LS8100 GREEN LASER

- Powerful:** 532 NM green laser (<5mw) 26mm x 110mm
- Accurate:** 4 point windage and elevation control
- Durable:** Black anodized 6061 T6 aluminum alloy
- Tireless:** 5 hours continuous run time with CR123 battery



KT81067

LS 8100 laser plus pressure switch with MT61167 Picatinny rail laser mount



KT81069

LS8100 laser with Picatinny mount and MT61169 Tri-rail barrel mount to add Picatinny rails and accessories on barrels 12mm- 24mm.



KT81072

LS8100 laser plus pressure switch with both quick-release and hard mount Picatinny hardware



KT9172 INFRARED LASER

- Powerful:** 850 nM infrared laser (<1mw) visible only with night vision gear
- Accurate:** 4 point windage and elevation control
- Durable:** Waterproof black anodized 6061 T6 aluminum construction
- Light weight & Compact:** 2 oz., 27mm x65mm
- Smart:** Includes momentary pressure switch
- Sturdy:** Includes both quick-release and hard mount Picatinny mounts
- Tireless:** 8 hours continuous run time with CR123 battery

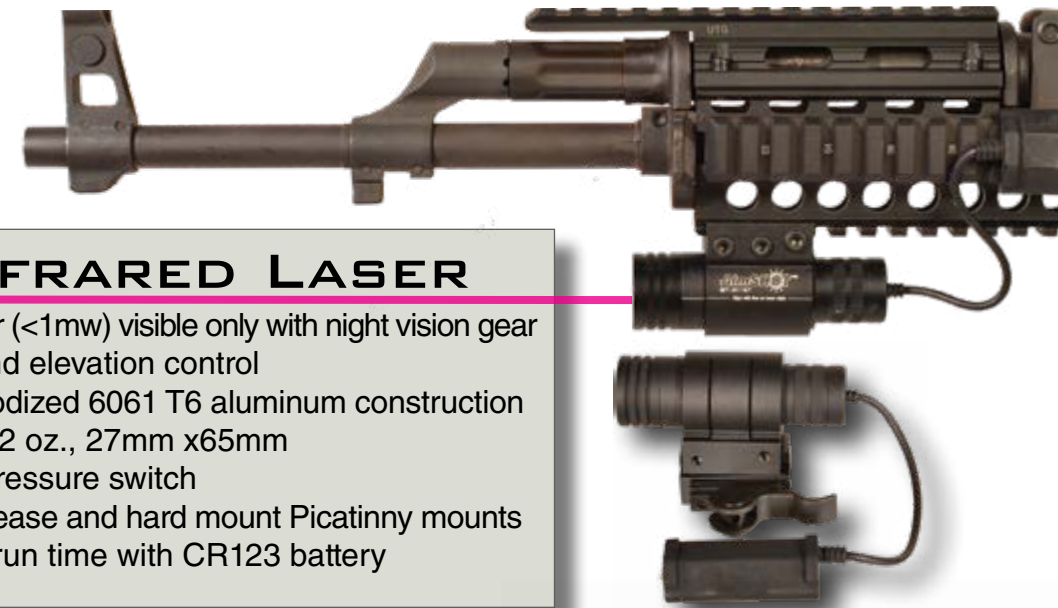

KT6132

- Sturdy:** 3 bolt Picatinny mount holds tight
- Powerful:** 632 nM red laser <5mw
- Tireless:** 4 hour run time on three LR44 batteries
- Durable:** Black anodized 6061 T6 aluminum construction
- Light Weight & Compact:** 1/2 oz., 16mm x46mm
- Quick:** Pressure Pad allows automatic on/off
- Smart:** Includes both traditional on/off tail cap and tape switch



KT6832 RED LASER

- Powerful:** 632 NM red laser
- Accurate:** 4 point windage and elevation control
- Durable:** Waterproof black anodized 6061 T6 aluminum alloy
- Sturdy:** Standard Picatinny mount for maximum stability
- Smart:** Includes both traditional on/off tail cap and rail



HEAT SEEKER

PATENTED

The most affordable heat detection system available
Use to find downed game in low light conditions



- Adaptable:** For the hunt, security, search & rescue, law enforcement, and detecting thermal loss in buildings and equipment
- Powerful:** 300 yard range (dependent on atmospheric conditions and temperature differential)
- Endurance:** 20+ hours run time on one 9V battery
- Customizable:** 7 levels of sound adjustment and 64 levels of gain adjustment
- Visual:** Use LED light meter to observe radiant heat differences
- Stealthy:** Use included ear bud that overrides screen output using only audio cues. Ability to toggle laser on/off for pin point accuracy

The AimShot HeatSeeker was designed to pinpoint game that has been shot and needs to be tracked. Using temperature differentials and an easy to view row of LEDs to show where the game/heat source is located even in heavy brush.

Included Accessories

Ear bud

Hard storage case

Carry pouch



CLASSIC MOUNTS

CLASSIC MOUNTS

- Reliable:** Tried and true accepted design
- Durable:** Construction of black anodized 6061 T6 aluminum
- Versatile:** Fits almost any rail system



MT 61168: Tri-Rail Barrel Mount for 12mm- 24mm barrels. Adds three rail sections for mounting accessories, lights, lasers, etc.



MT 61167: Laser/light Picatinny Rail Mount for 1" and 7/8" accessories. Includes shim to fit 7/8" lasers and other accessories. 3 screw system outer two screws hold mount to rail, middle screw holds light in mount, so you can remove light without removing mount and vice versa.

ACCESSORIES

Snag a wire on your last range day?
Time to upgrade that laser system?
We have you covered!

FL 8010

Flashlight spring-cable tape switch



FL 8012

Flashlight on/off tail-cap



FL 8013

Rail Mounted straight cable pressure switch for TX lights



FL 8014

Wireless rail mounted pressure switch replacement for TX/TZ/KT8103



GL 8010

Curly cable tape switch for 8100/6800 series lasers



GL 8011

Straight cable tape switch for 8100/6800 series lasers



GL 8012

Laser on/off tail-cap for 8100/6800 lasers



GL 8013

Rail mounted pressure switch with straight cord for 8100/6800 series lasers



AimShot gives you the strength of a top brand with a 21 year history of doing things differently and better. With industry leading patented designs and market firsts, AimShot has been there every step of the way in the accessory market. We are not here to copy other products, but to design products that work better and provide the features and benefits that our customers demand. We design all of our products in house and use the best materials to produce better products, while maintaining the best value.

Market firsts and patents- AimShot holds patents on our original laser bore sights, wireless adjustable beam lighting systems, HeatSeekers, and our latest innovation- the KeyMod and M-Lok quick releases.

Innovation and products that no one else in the market produces.

With many of our products in use with the US Military here and overseas, we stand behind our products and are proud to have our products in the hands of Law Enforcement, Military and Consumers in the United States.

AimShot[®]

BE READY *Est. 1998*



AIMSHOT HEADQUARTERS
11770 Haynes Bridge Rd.
STE 205-336
Alpharetta, GA 30009 USA
1.678.845.8899
aimshot@aimshot.com



Designed, Assembled,
& Packaged in the USA

WWW.AIMSHOT.COM



20240401